

Product
sheet

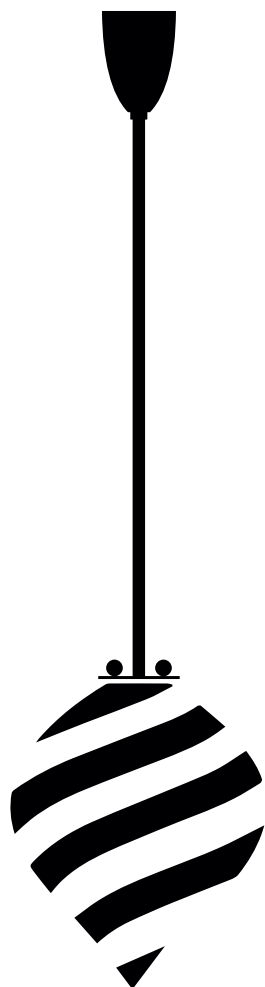

Instructions

- Must be installed by a professional
- Handle items carefully
- Use appropriate screws and equipment
- Wear gloves during installation

Assembly time

1h00

Number of people required

2

1

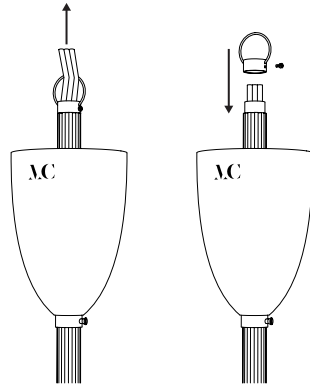

Unscrew the hook and insert the wires before screw it back.

2

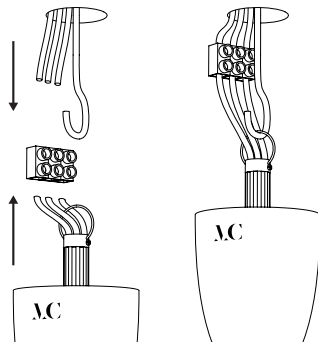

Connect the wires to the mains after setting up the hook.

3

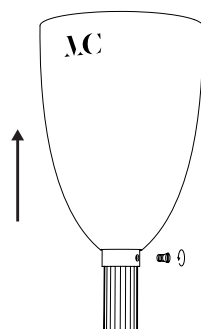

Pull up the thread guard after unscrewing the ring's screw.

4

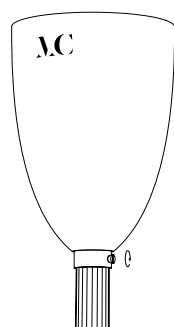

Once set, screw it back.

To set the lamp, follow thoses steps in this order : 3 - 4

1

Unscrew the two pieces while holding the glass.

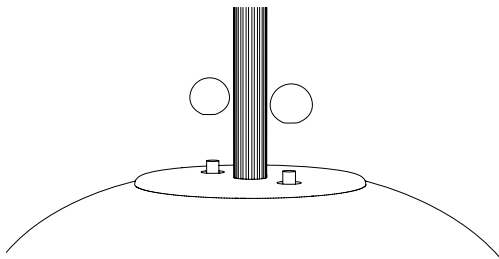

2

Remove the glass carefully.

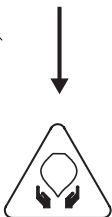
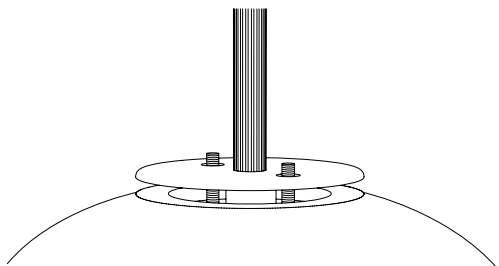

3

Unscrew the bulb to replace it.

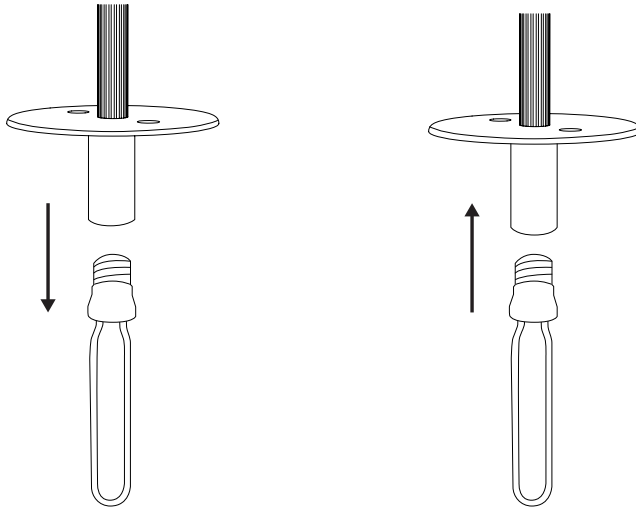

4

Put back the glass thanks to the pieces.

