

Installation
instructions

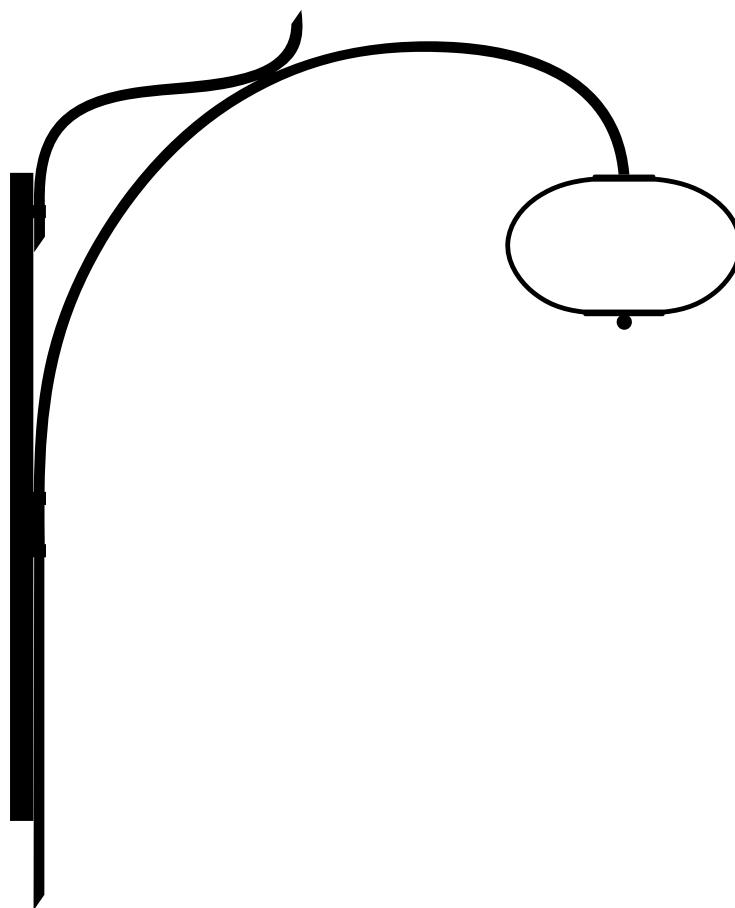

Instructions

- Must be installed by a professional
- Handle items carefully
- Use appropriate screws and equipment
- Wear gloves during installation

Assembly time

1h30

Number of people required

2

1

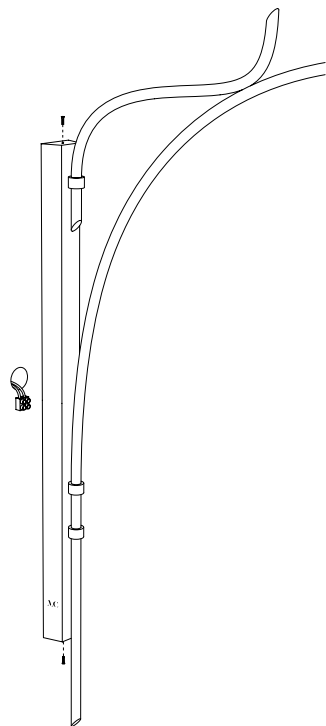

Free the plate.

2

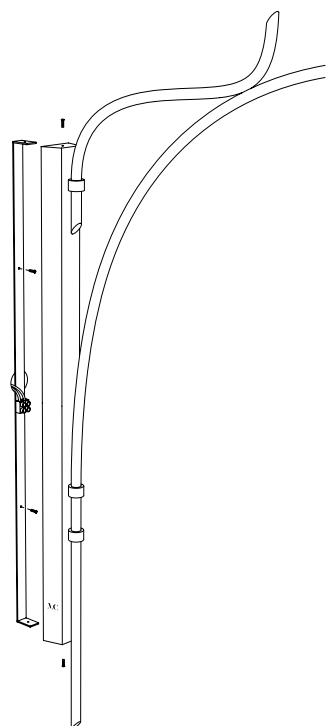

Fix the plate to the wall with dowels.

3

Connect the wires to the mains.

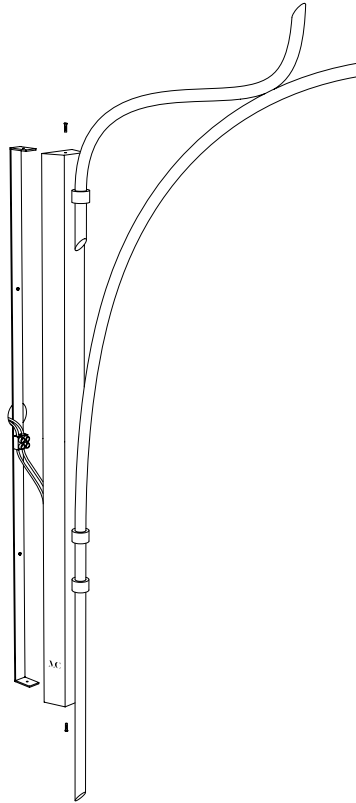

4

Fix the light to the plate.

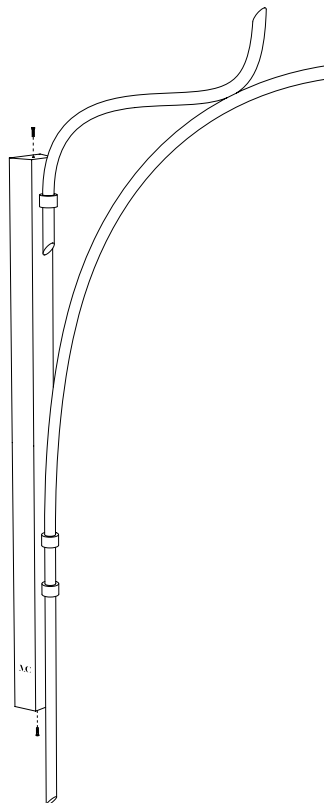

To set the lamp, follow thoses steps in this order : 3 - 4

1

Unscrew the two pieces while holding the glass.

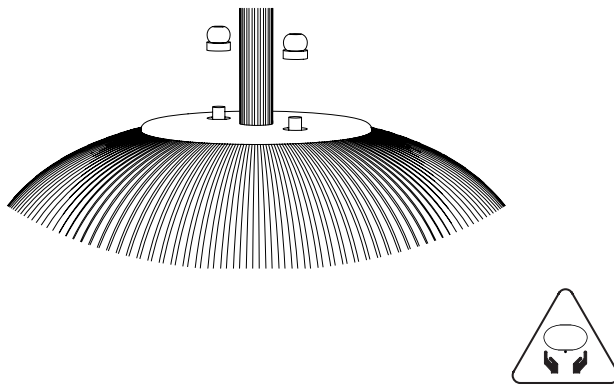

2

Remove the glass carefully.

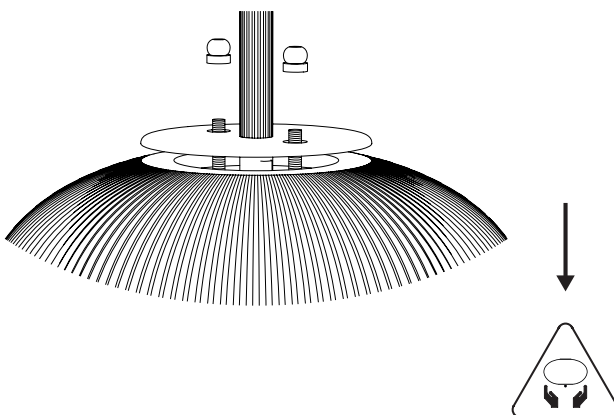

3

Remove the bulb by pulling it down.

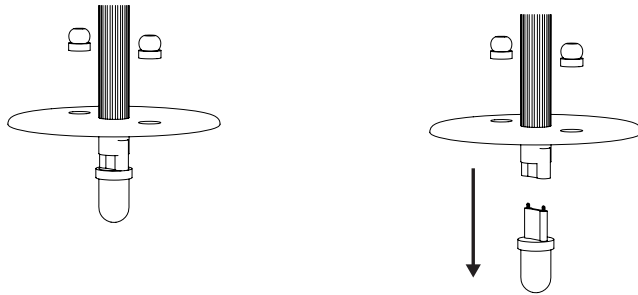

4

Put the glass back thanks to the pieces.

