

Installation  
instructions

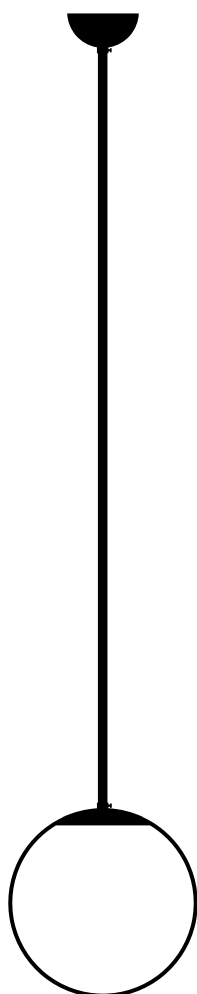

### Instructions

- Must be installed by a professional
- Handle items carefully
- Use appropriate screws and equipment
- Wear gloves during installation

### Assembly time

1h00

### Number of people required

2

1

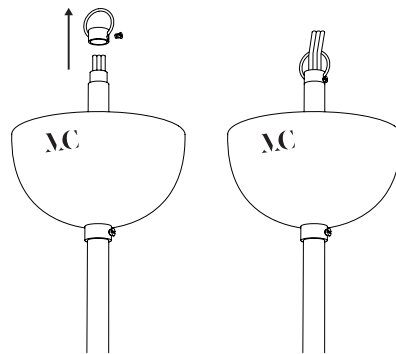

Unscrew the hook and insert the wires before screw it back.

2

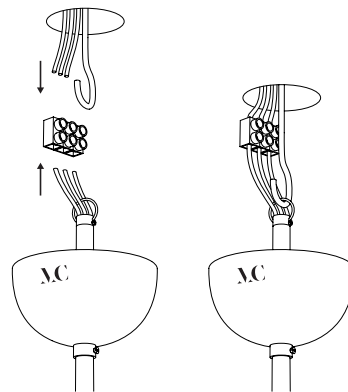

Connect the wires to the mains after setting up the hook.

3

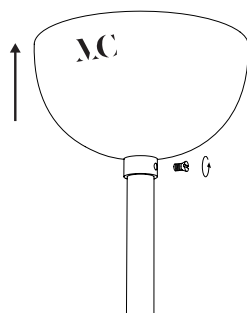

Pull up the thread guard after unscrewing the ring's screw.

4

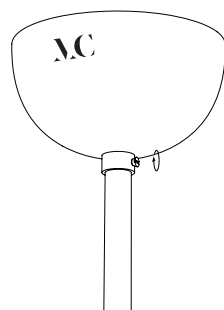

Once in place, screw it back.

**1**

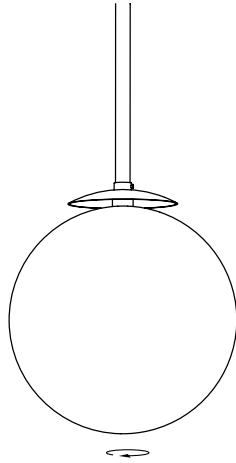

In case of light bulb replacement. Unscrew the glass globe.

**2**

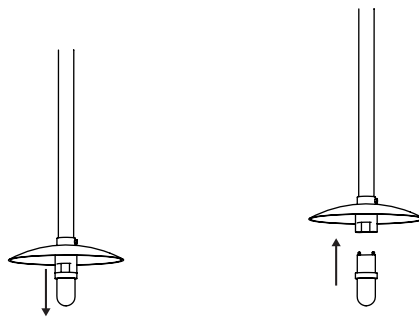

Insert the light source into the base.

**3**

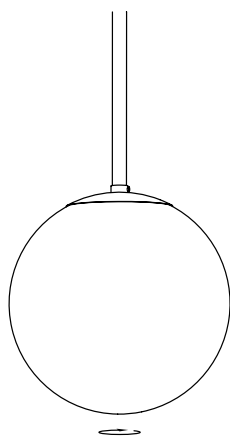

Screw the glass globe up to the resistor.  
Beware ! Do not tighten stronger than natural resistance.