

Installation
instructions

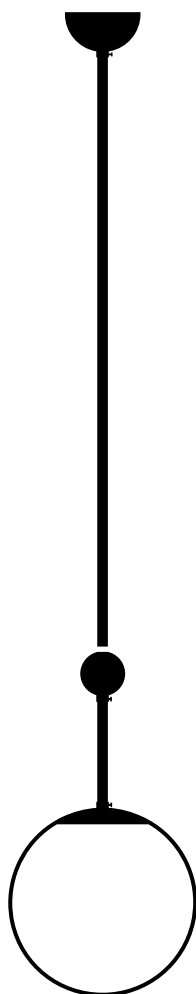

Instructions

- Must be installed by a professional
- Handle items carefully
- Use appropriate screws and equipment
- Wear gloves during installation

Assembly time

1h00

Number of people required

2

1

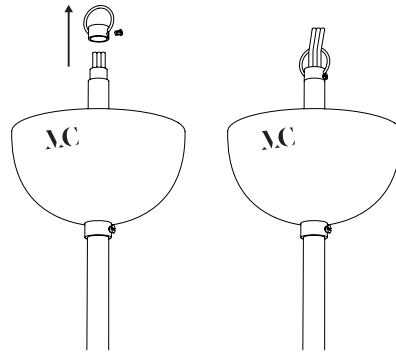

Unscrew the hook and insert the wires before screw it back.

2

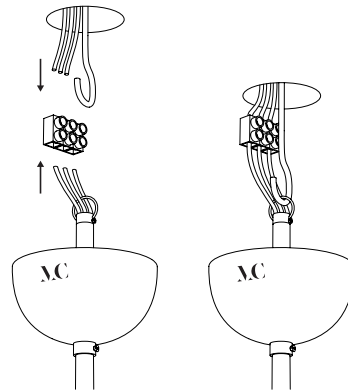

Connect the wires to the mains after setting up the hook.

3

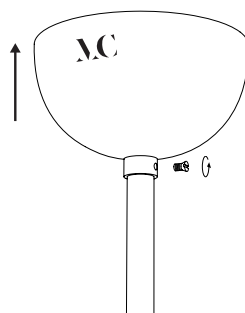

Pull up the thread guard after unscrewing the ring's screw.

4

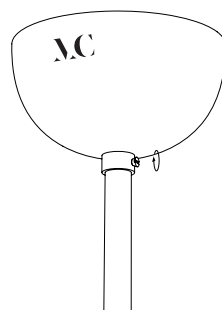

Once in place, screw it back.

1

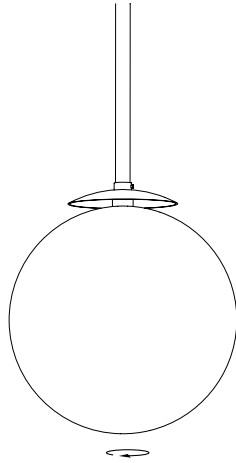

On the case of light bulb replacement. Unscrew the glass globe.

2

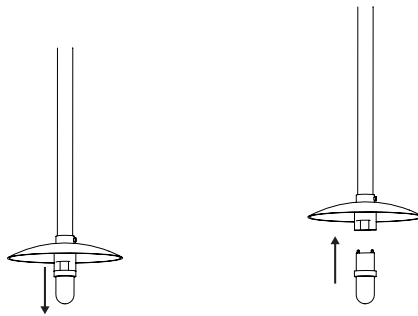

Insert the light source into the base.

3

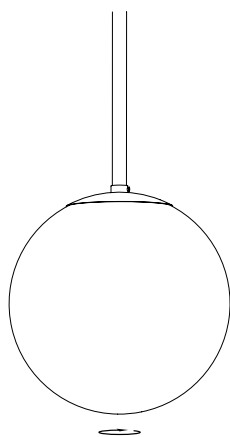

Screw the glass globe up to the resistor.
Beware ! Do not tighten stronger than natural resistance.

1

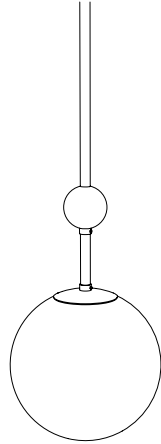

To adjust the position of the brass ball, follow those steps.

2

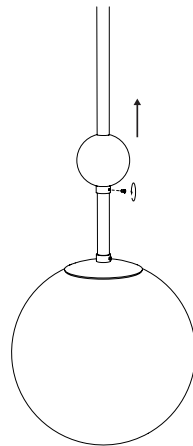

Unscrew the ring's screw and pull up the brass ball.

3

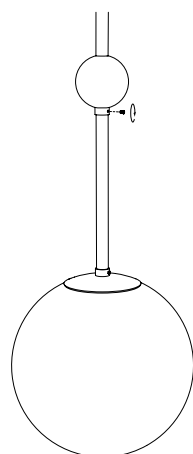

Screw back the ring's screw.