

Installation
instructions

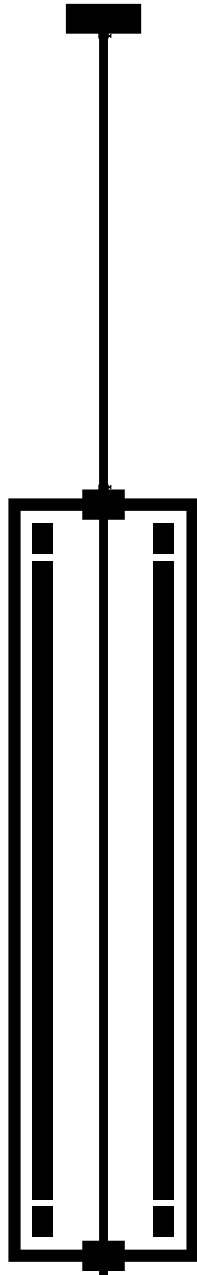

Instructions

- Must be installed by a professional
- Handle items carefully
- Use appropriate screws and equipment
- Wear gloves during installation

Assembly time

1h30

Number of people required

2

1

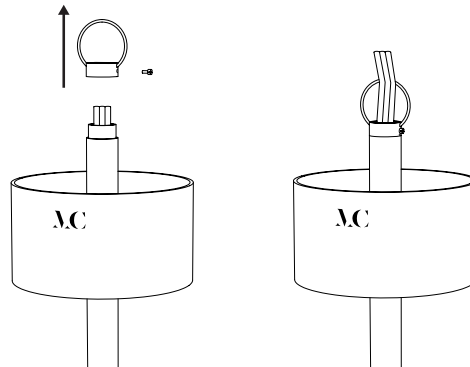

Unscrew the hook and insert the wires before screw it back.

2

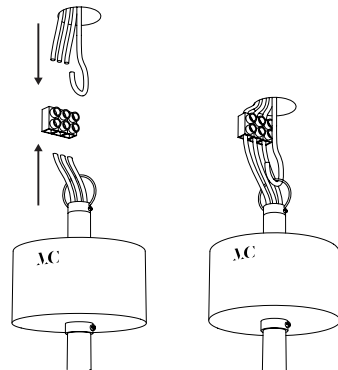

Connect the wires to the mains after setting up the hook.

3

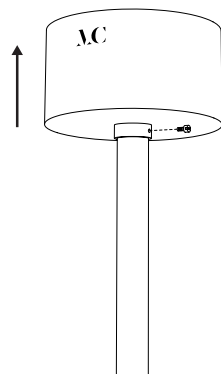

Pull up the thread guard after unscrewing the ring's screw.

4

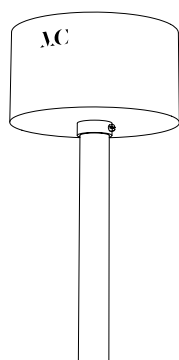

Once in place, screw it back.

1

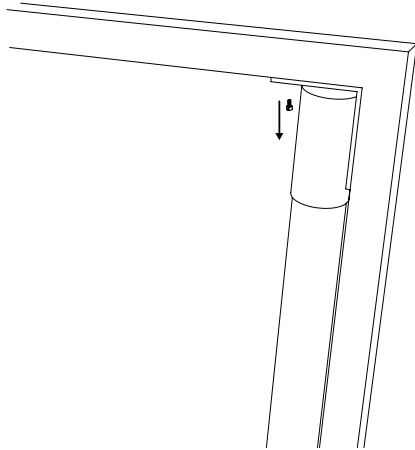

In case of neon tubes replacement, unscrew the screw.

2

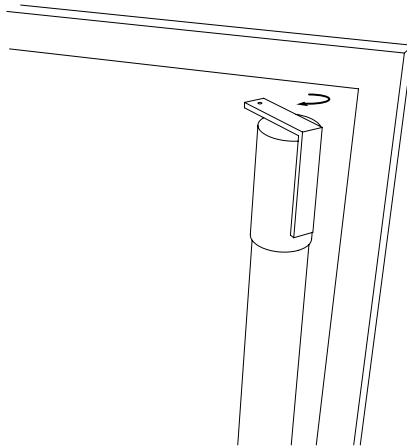

Recline the tube.

3

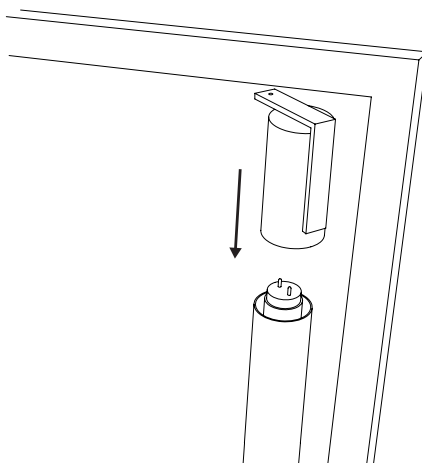

Remove the neon tube.

4

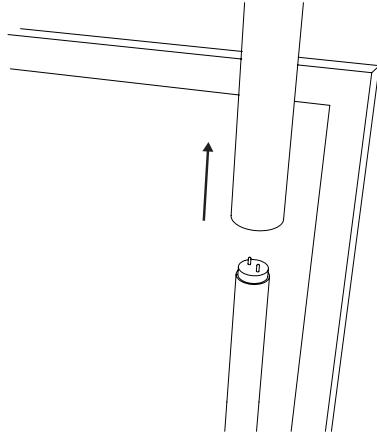

Put off the opalin glass tube.

5

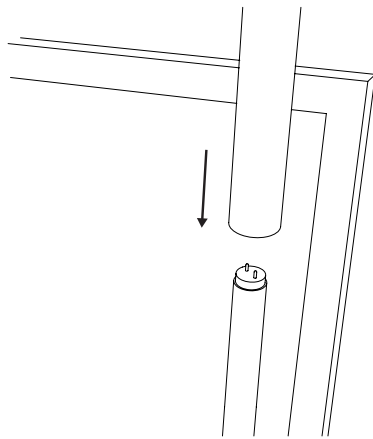

Put the opalin glass tube on the new neon tube.

6

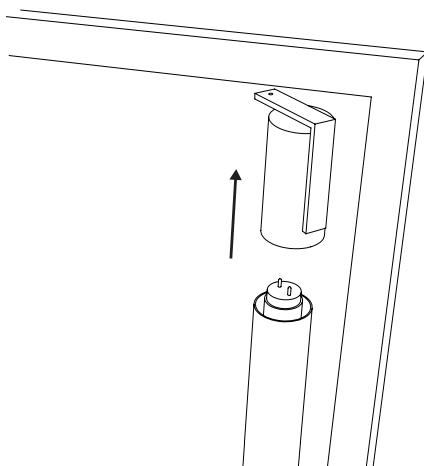

Insert the new neon tube into the base.

7

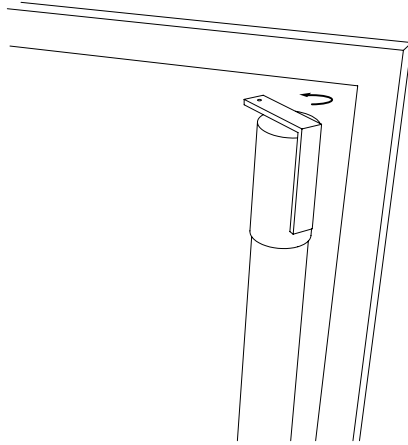

Recline the tube back.

8

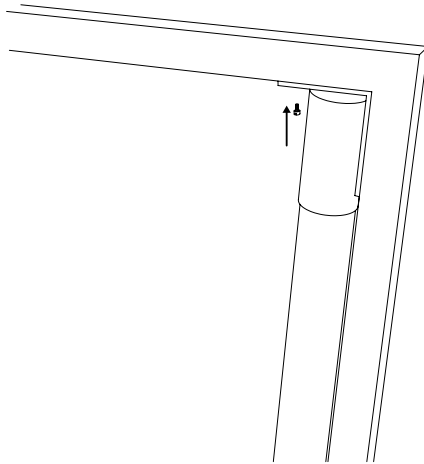

Screw back the screw.