

Installation  
instructions

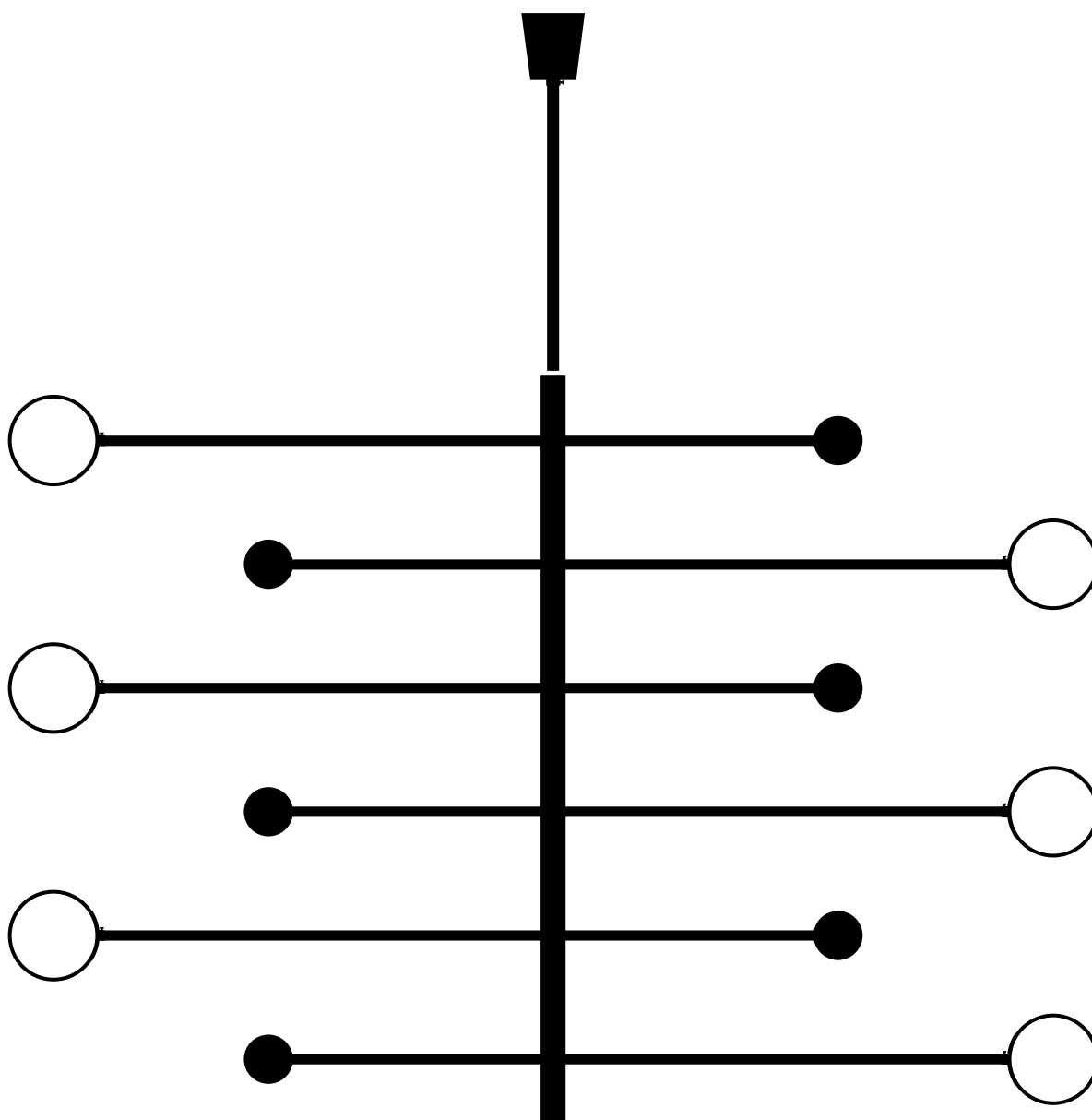

### Instructions

- Must be installed by a professional
- Handle items carefully
- Use appropriate screws and equipment
- Wear gloves during installation

### Assembly time

1h30

### Number of people required

2

**1**

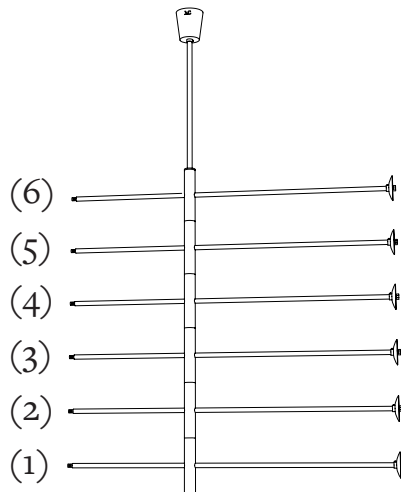

Chandelier set up is done on the ground, after putting it off from its transport box.

**The arm (1), the lowest of the chandelier, is fixed and therefore, should not be rotated.**

**2**

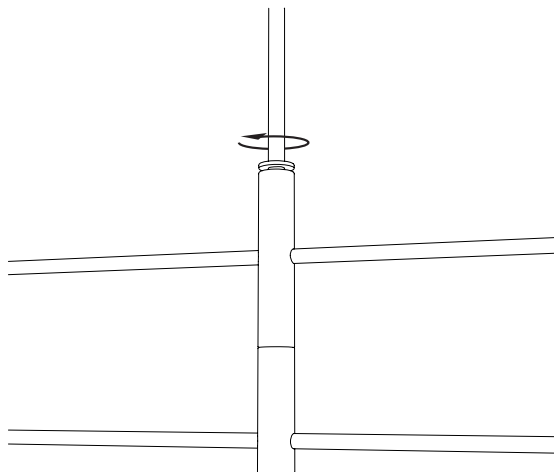

Untighten the ring slightly.

**3**

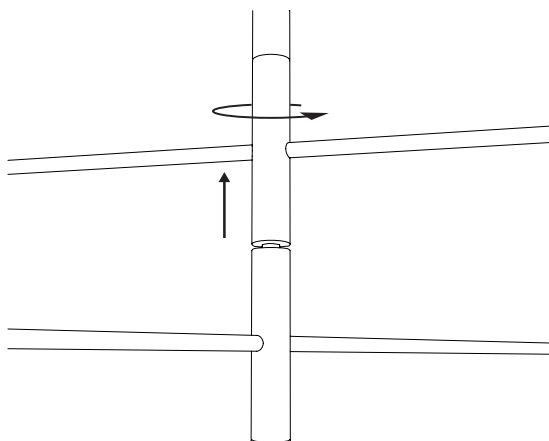

Starting with the arm (2), spread the block and rotate until placement.

**Do not force, arms (2),(3), (4), (5) and (6) need to be rotated 30 degrees only in the same sense.**

4

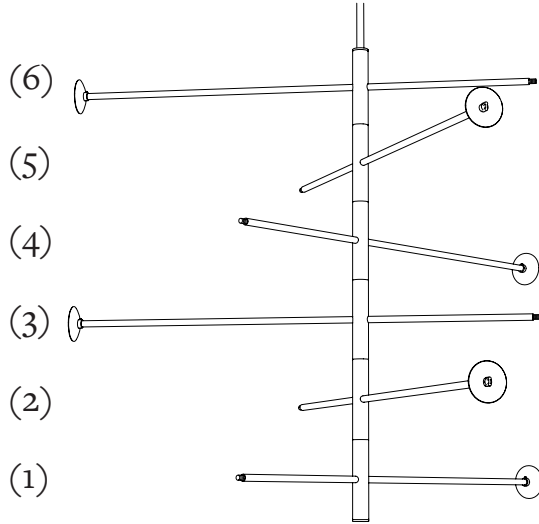

Continue to arm (6).

5

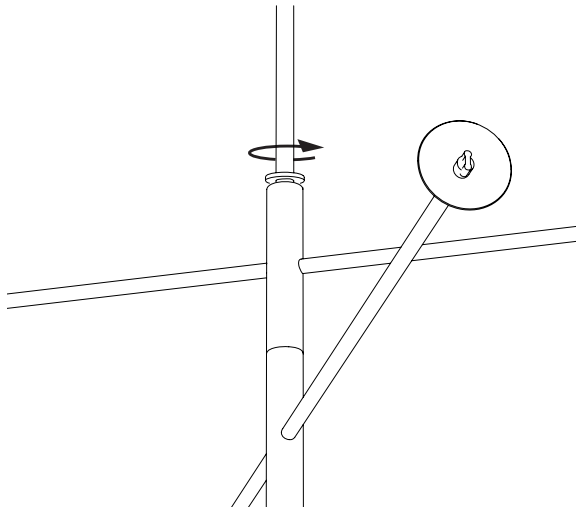

Tighten the ring back.

6

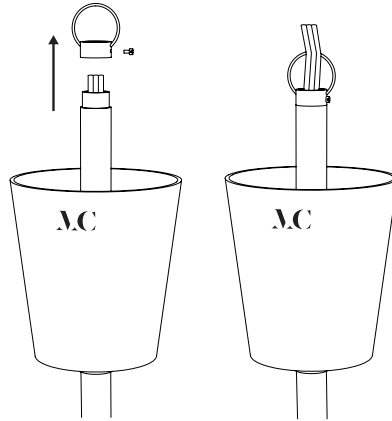

Unscrew the hook and insert the wires before screw it back.

7

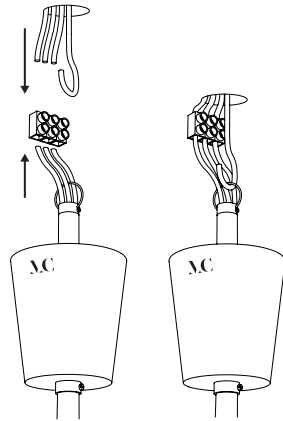

Connect the wires to the mains after setting up the hook.

8

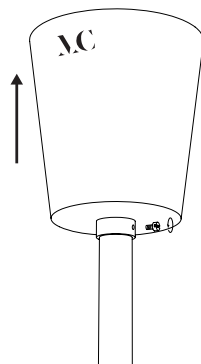

Pull up the thread guard after unscrewing the ring's screw.

9

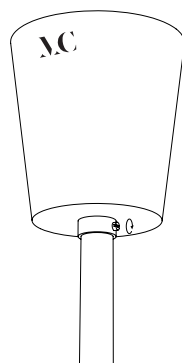

Once set, screw it back.

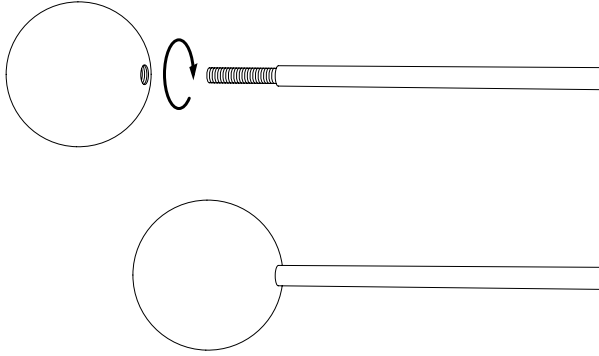

The brass spheres are screwed to threaded tubes.

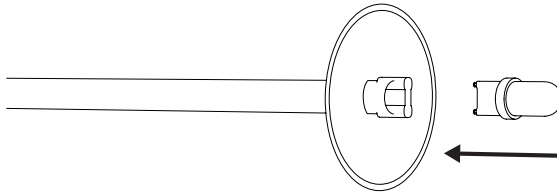

For the light sources, insert the light source into the base.

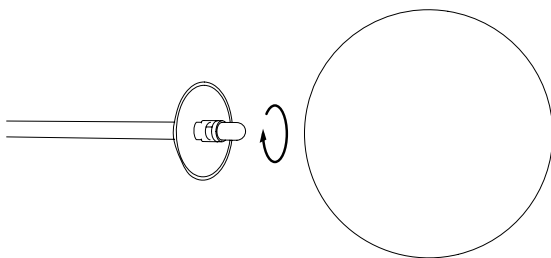

Screw the glass globe up to the resistor. Beware ! Do not tighten stronger than natural resistance.

10

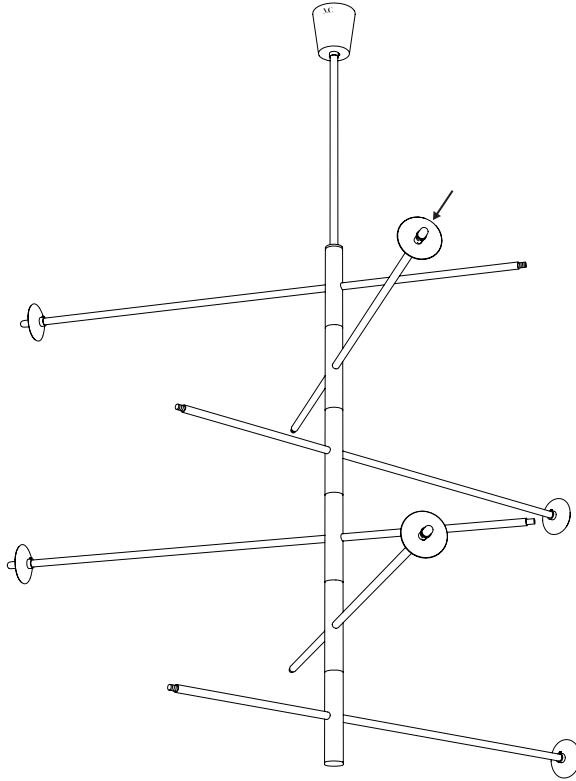

Install bulbs from bottom to top.

11

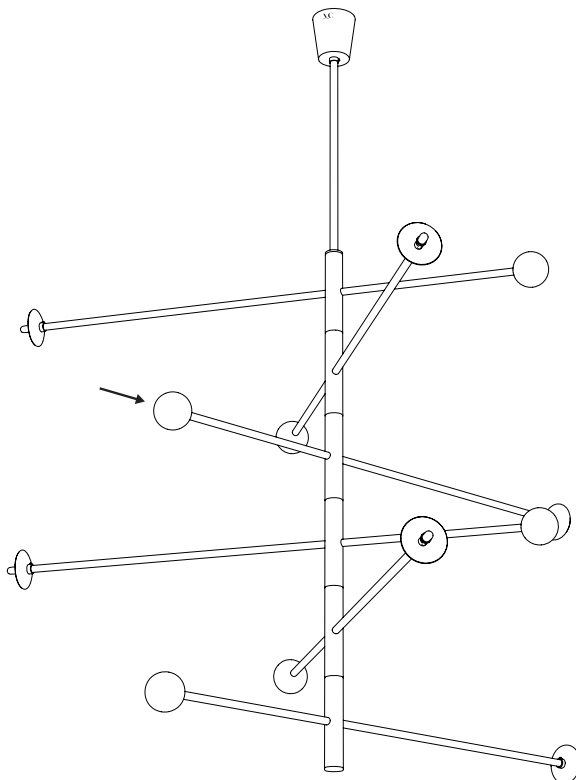

Screw brass spheres from bottom to top.

12

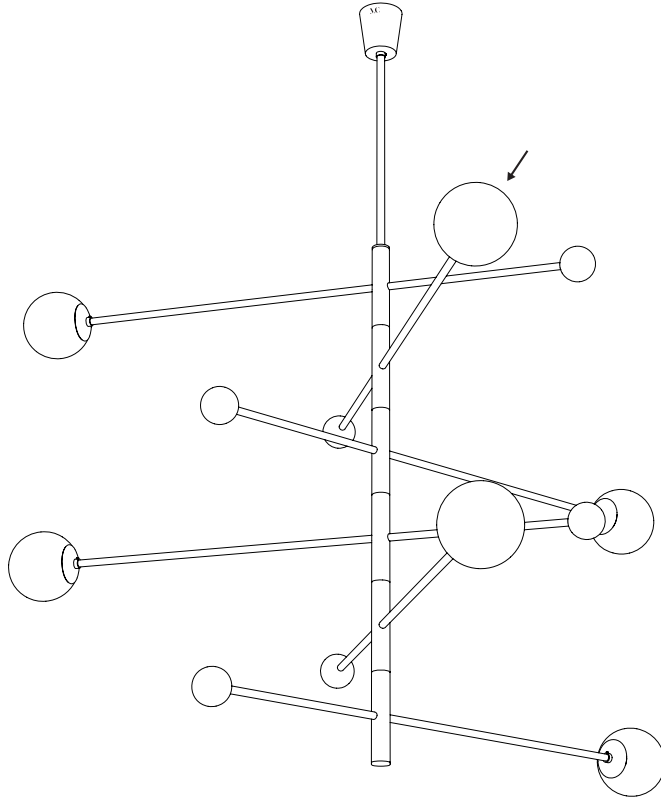

Screw glass spheres from bottom to top.